

# DOLPHIN

Automatic Key Cutting Machine  
XP-005L

## User Manual

V1.0

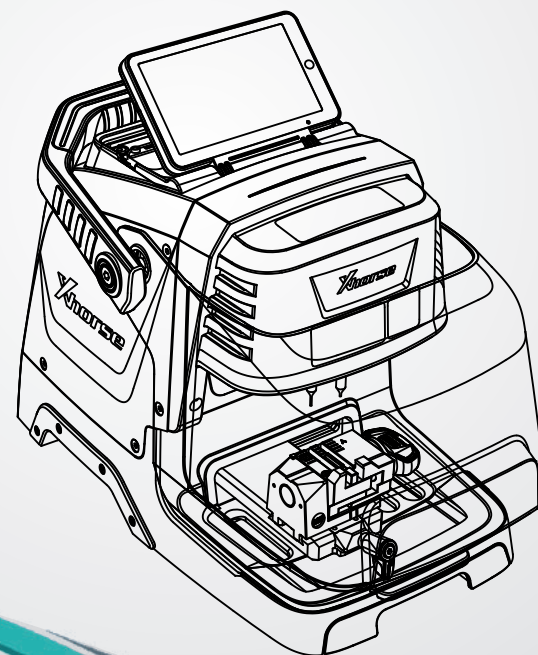



**XP-005L**  
Automatic Key Cutting Machine

## TABLE OF CONTENTS

1. Safety precautions and warnings .....	02
2. General information	
2.1 Machine description .....	03
2.2 Machine characteristics .....	03
3. Product packaging checklist .....	04
4. Overview	
4.1 Structure diagram .....	06
4.2 Specification .....	07
4.3 Software overview .....	09
5. Installation instruction	
5.1 Cutter and probe installation .....	10
5.2 Cutter and probe uninstallation .....	11
5.3 Clamp installation .....	12
5.4 Pictures of clamps .....	13
5.5 Clamp M5 instruction .....	14
6. Operation instructions	
6.1 Use your smart phone APP to connect machine .....	15
6.2 Cutting calibration .....	16
6.3 How to use the vehicle database .....	19
6.4 How to use cut by code .....	22
6.5 Universal Duplication .....	29
6.6 How to use all key lost .....	32
6.7 How to use find bitting .....	35
6.8 Special cutting option .....	38
7. System introduction	
7.1 Machine Parameter .....	39
7.2 System setting .....	42
7.3 History .....	42
7.4 My favorite .....	43
7.5 Update Center .....	44
7.6 WLAN Connection .....	46
8. Maintenance .....	47
9. Warranty and after-sale description .....	47

## 1. Safety precautions and warnings

To avoid injuries to operators and damages to machines, please read this product user manual carefully before you start and follow the safety notes listed below:

- Always use the machine under safe environment
- Wear protective goggles that are in line with ANSI standard
- Put down the protective shield when the machines is working
- Do not have clothes, hair, hands and other tools close to the machine when it is working
- Do not leave the machine unattended when it is working
- Do not use a damaged or loose socket
- Unplug the machine when it is not in use for a long time
- Do not place the machine in a place that is damp, greasy and dusty
- Do not put things like tool or containers on the machine
- Put the machine on a flat and firm surface
- Keep the machine dry and clean
- Unplug the machine instantly under unusual circumstance

## 2. General information

### 2.1 Machine description

Dear customers, thank you for choosing XP-005L automatic key cutting machine.

Dolphin XP-005L is a portable machine, with a small volume and light weight, is particularly and carefully designed for locksmiths worldwide.

This product user manual provides operating instructions for you to use the machine correctly and safely. To avoid injuries and financial loss, please carefully read this manual through before you start to operate the machine. And we kindly remind you to keep this manual properly for future reference.

All the information and illustrations in this document are for guidance only. Xhorse Electronics reserves the right to alter products designs, dimensions or info to improve the products quality. The contents of this document are fully protected by Copyright and may not be copied or reproduced in any form (e.g. mechanical, electronic, printing or video recording), without written permission from Xhorse Electronics.

### 2.2 Machine characteristics

- Built-in database
- Support APP Control
- Intelligent operating system
- Smart LED indicator
- Angle adjustable LCD touch screen
- Support WiFi and Bluetooth
- Support multiple languages<sup>①</sup>
- Built-in lithium battery<sup>②</sup>
- All-aluminum body structure
- High precision ball screw
- High rigidity cross rail
- Cutter and probe work in parallel
- Support Multiple Clamps
- Support Sided/Track/Tibbe Key<sup>③</sup>









① Only for the global version











② With/Without built-in lithium battery depending on the machine version

③ Optional clamps are required for certain keys

### 3. Product packaging checklist

A full package of XP-005L should include accessories listed in the following table. Please check when you get this product and contact your distributor if anything in the table is missing.

Name	Sample picture	Quantity	Description
Machine		1	Key cutting machine
Clamp M5 and link stopper		1	Key clamp
Clamp M3 (optional)		1	FO21/SX9 key clamp
Clamp M4 (optional)		1	Household key clamp
1.5mm cutter		1	Cutting tool (φ1.5*φ6*40L)
2.5mm cutter		1	Cutting tool (φ2.5*φ6*40L)
Probe		2	Probing tool (φ1.0*φ6*40L)
2mm+4mm 3mm hexagon bar wrench		1	Tracer point tool, key fixation on clamp M1
3mm hexagon bar wrench		1	Clamp installation tool
6mm hexagon bar wrench		1	Clamp installation tool

Protective bracket		1	Protect nose fix nose
Power adapter		1	Power supply
1.5m Power cord of Mainland China standard		1	Connect to power
1.5m Power cord of UK standard (optional)		1	Connect to power
1.5m Power cord of US standard (optional)		1	Connect to power
1.5m Power cord of EU standard (optional)		1	Connect to power
Built-in battery (optional)		1	Portable power supply
Brush		1	Cleaning tool
Product quality certificate		1	Factory inspection report and packing list
User manual		1	Machine assembly/adjustment/operatio n instruction

## 4. Overview

### 4.1 Structure diagram



### 4.2 Specification

Input voltage	24V DC
Power	160W
Principal axis rotation speed	12500rpm
Motor Torque	0.15N.m
LCD resolution	1280*720
Working temperature	-10-50°C
Humidity	10-90%
Machine size	390mm*220mm*270mm
Package size	495mm*400mm*360mm
Net weight	13kg
Gross weight	18.5kg



Machine size



Package size

## 4.3 Software overview

### 4.3.1 Introduction

- Supporting self-calibration
- Supporting key duplication and cutting for vehicle keys
- Supporting universal key decode for multiple key types
- Operation on APP through Bluetooth
- Build-in key database

### 4.3.2 Update online

- Machine firmware and database upgrade via WIFI directly

## 5. Installation instruction

### 5.1 Cutter and probe installation

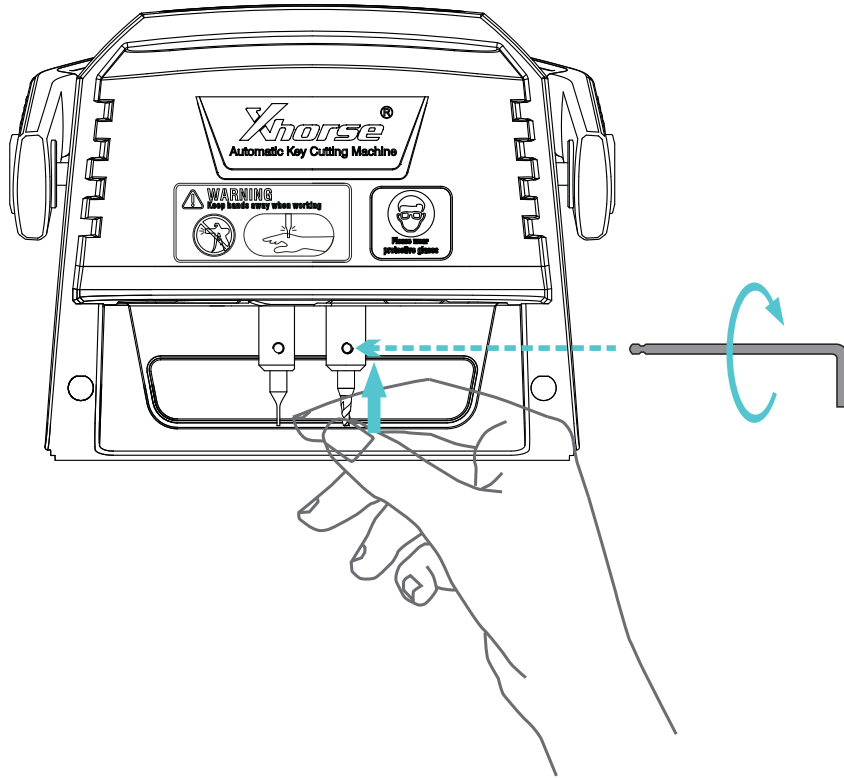

#### Installation steps:

- 1) Put the cutter into the cutter mounting hole and push the cutter to the limit. When the screw is perpendicular to the notched part of the side of the milling cutter, turn the screw clockwise until the cutter is locked and fixed it.
- 2) Push the probe into the probe mounting hole and push the probe to the limit. Turn the screw clockwise until the probe is locked and fixed it.

Do not replace the locking screws of different specifications (at the probe/milling cutter). It's recommended to use the locking screws with the original factory standard or the same specifications.

### 5.2 Cutter and probe uninstallation

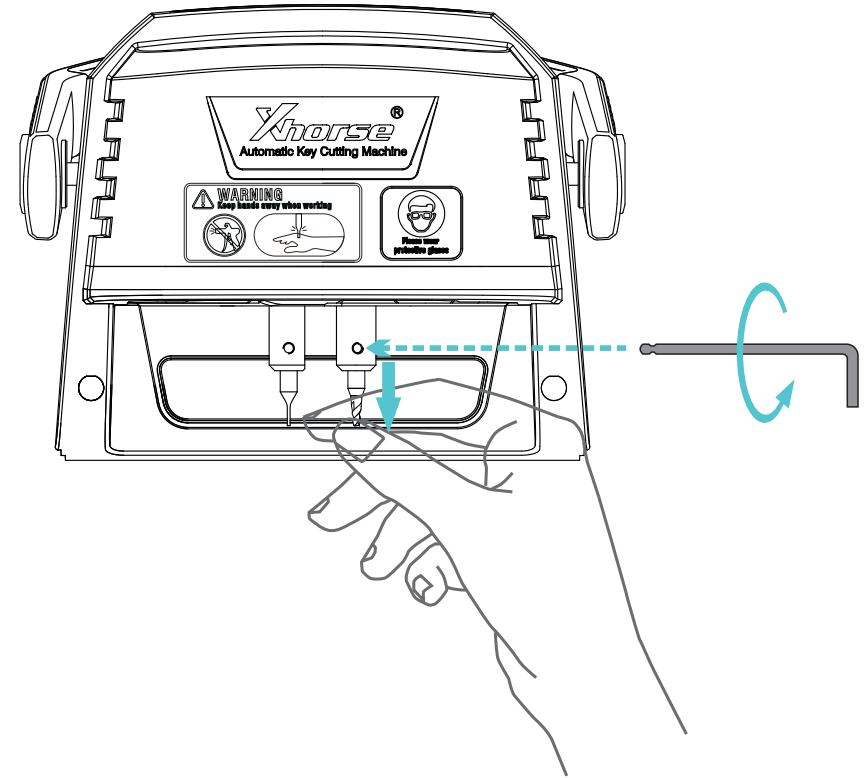

#### Uninstallation steps:

- 1) Unscrew the locks for cutter and probe counter-clockwise until they are loosened off.
- 2) Take the cutter or probe off when it is loose.

### 5.3 Clamp installation

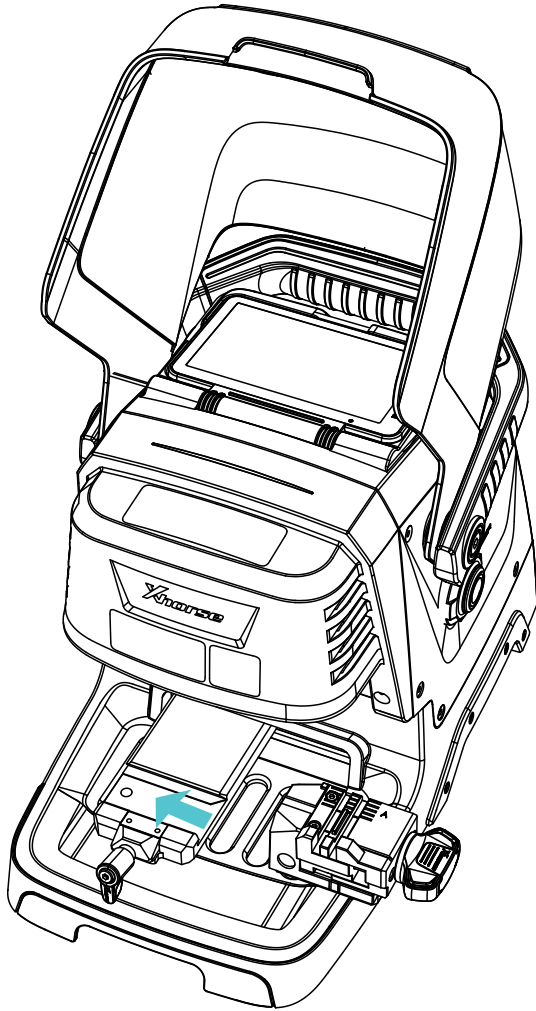

Installation steps:

- 1) Unscrew the clamp locking screw.
- 2) Choose the proper clamp for your keys, slide it in to the clamp holder and push it to the limit from right side.
- 3) Fix the clamp locking screw until the clamp is locked.

### 5.4 Pictures of clamps

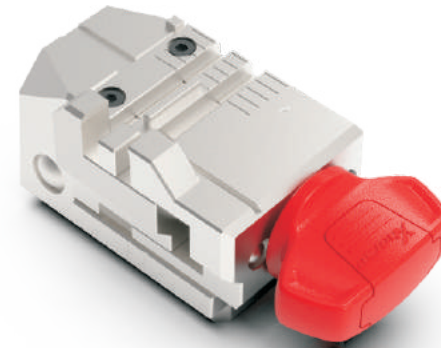

Clamp M5

Supporting type (as picture below)

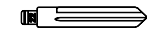

Standard single/double sided key

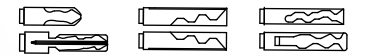

4 Track external 2 Track external 4 Track internal

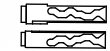

Channel track



Clamp M3

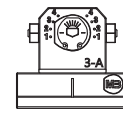

Support type (FO21 example)

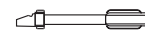

FO21

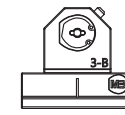

Support type (SX9 example)



SX9



Clamp M4

Supporting type (as picture below)

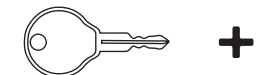



## 5.5 Clamp M5 instruction

The device adopts M5 clamp with two sides of A and B. Users can turn the clamp surface to cut according to cutting needs, it's no need to repeated install and uninstall to replace different clamps. Here are the method of using the M5 clamp.

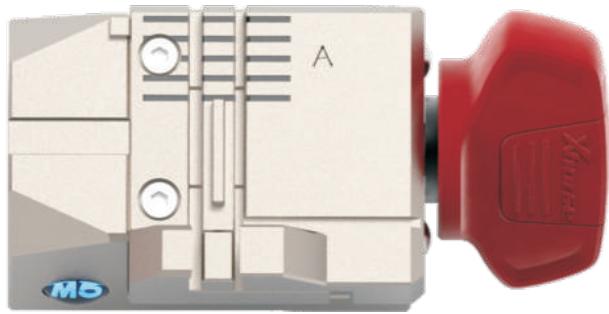

- 1) Loosen the "key lock knob" counterclockwise to make the right slider of the clamp to the right limit.

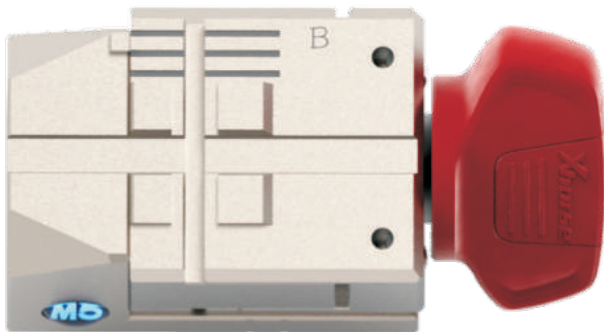

- 2) Turn the movable module clockwise, and turn the clamp from side A to side B. Tighten the "key lock knob" clockwise to lock the clamp.

## 6.Operation instructions

The system needs to initialize for first use. The steps as follows:

### 6.1 Use your smart phone APP to connect machine

1. Users can download Xhorse APP in the App Store to obtain it, or directly scan the QR code as shown below.
2. Power the machine and turn it on, open Xhorse APP, switch to the CNC machine interface, click on "Switch Device" and select Dlophin II.
3. Click on "Select" and turn on Bluetooth, click the SN of the device to connect to the machine (Users can set up the automatic connection function according to their needs).



Scan QR Code to download Xhorse APP

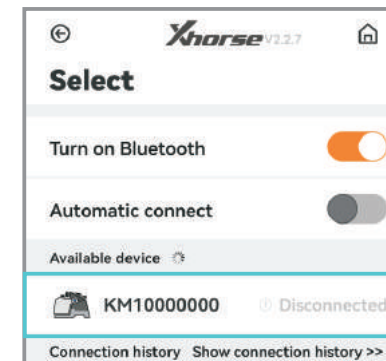

(The following operations can be completed as the same method on the APP )

## 6.2 Cutting calibration

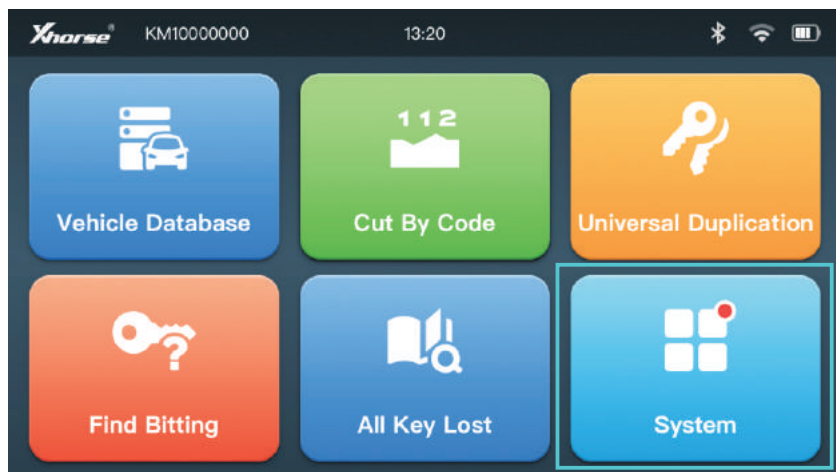

1) Click on "System" on the operation main interface.

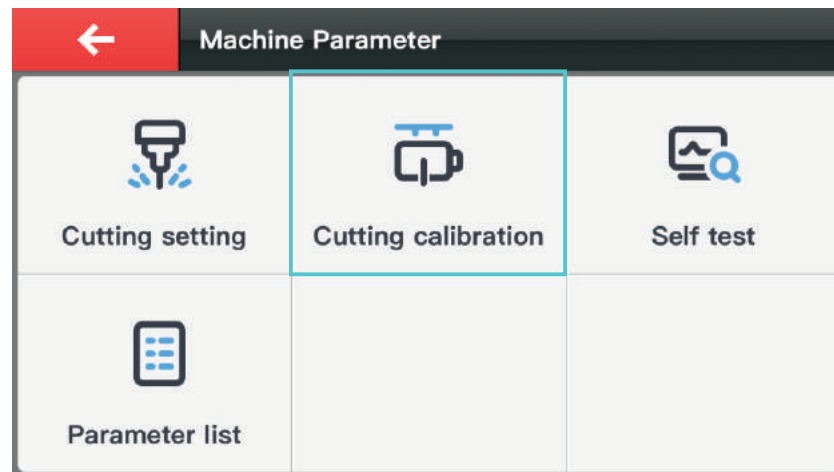

3) Click on "Cutting Calibration".

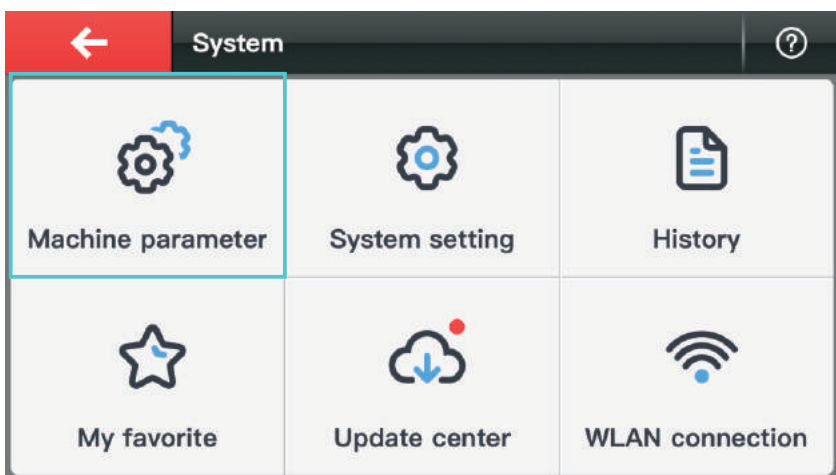

2) Click on "Machine Parameter".

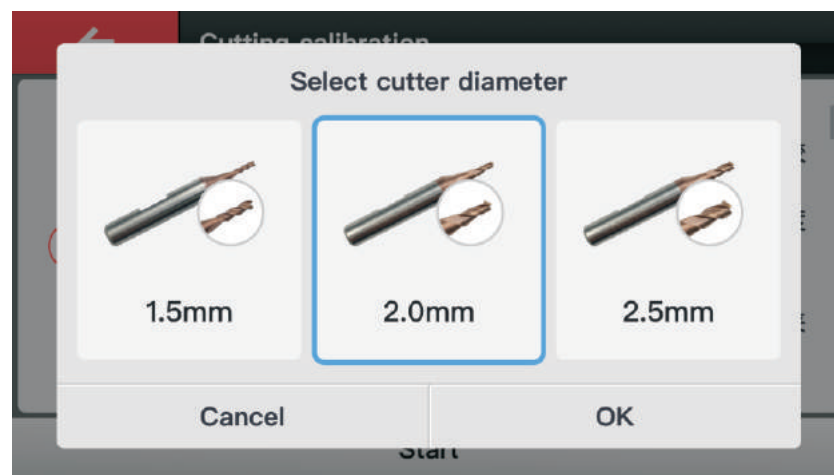

4) Please select the diameter of the milling cutter that you installed.

### 6.3 How to use the vehicle database

Make sure the model and year of the car first before you use the vehicle database.

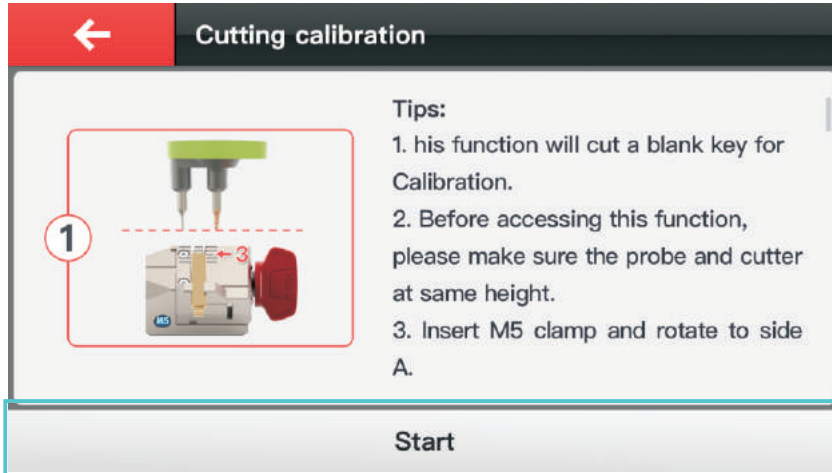

5) Operate by following the tips and click on "Start".  
\*Do not use the key that has cutted, you must use a brand new HON66 key blank.

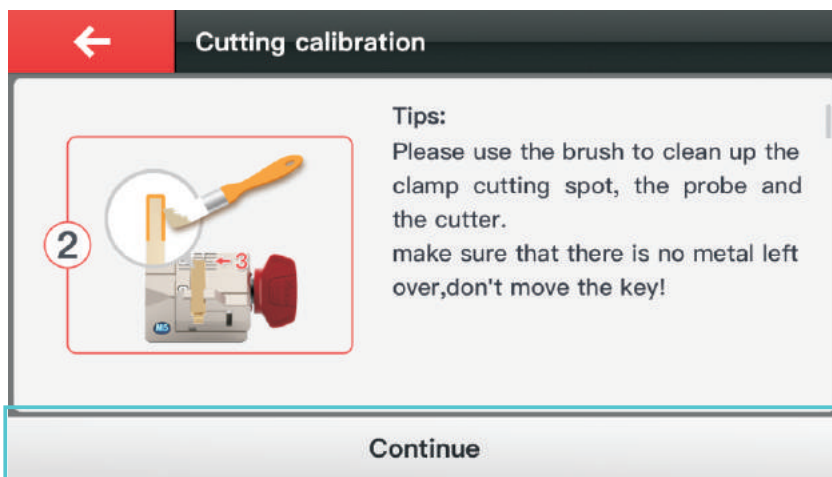

6) Clean the cutter, probe and working area with a brush.  
Click on "Continue" for finish cutting calibration.



1) Click on "Vehicle Database".

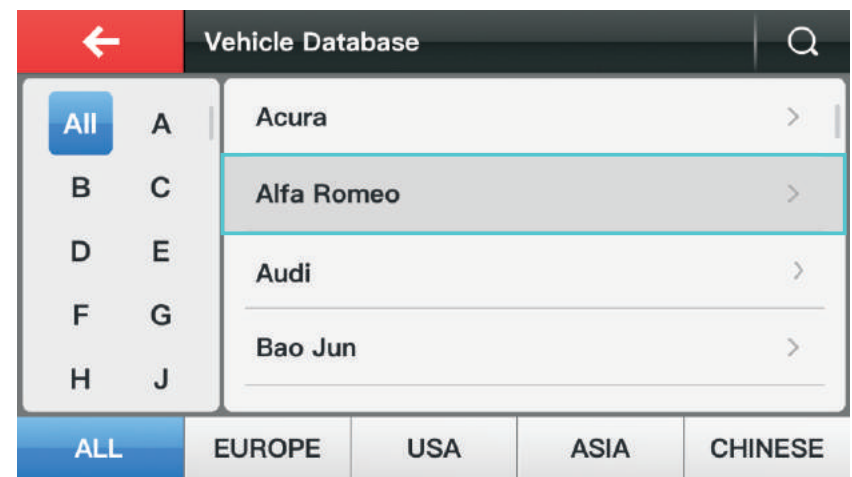

2) Select or input a car maker and enter next interface.

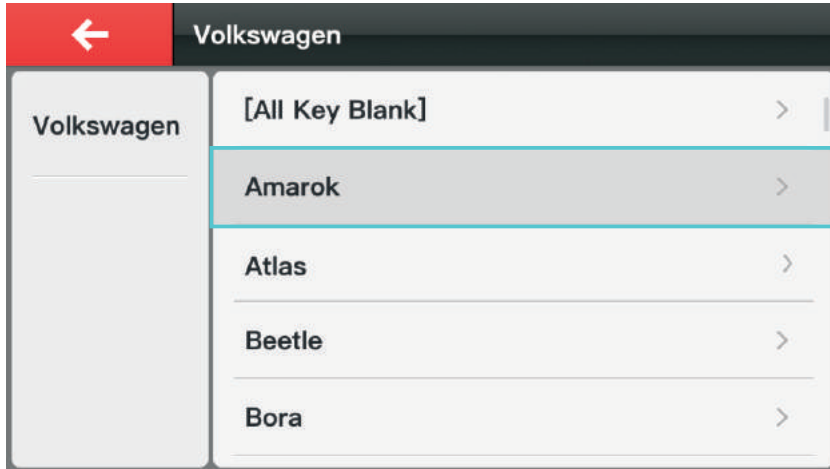

3) Select car model and enter next interface.

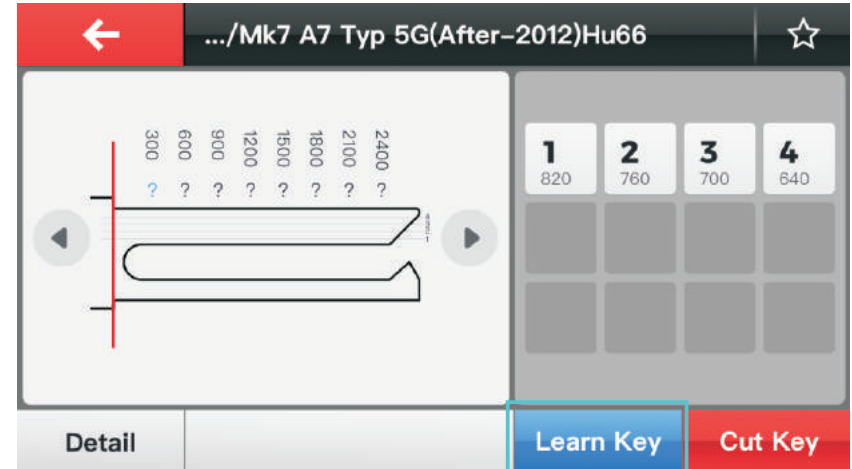

5) Follow the tips place the key correctly and click on "Learn Key".



4) Click on type and year to enter processing interface.

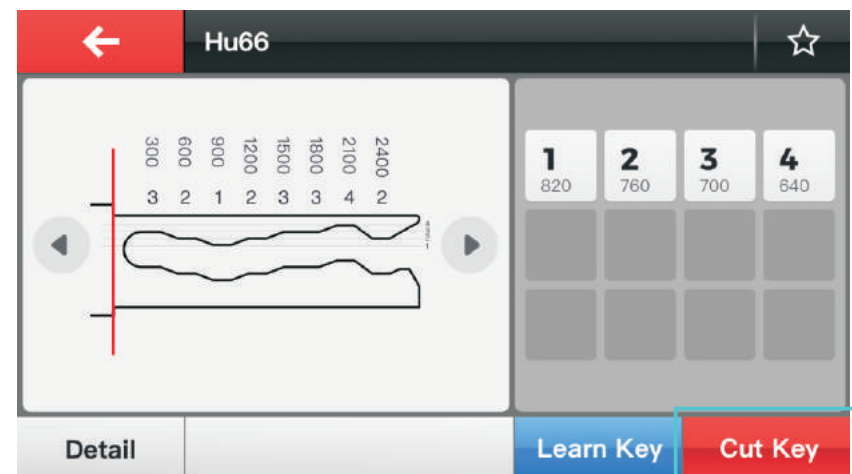

6) Obtain original key bitting and click on "Cut Key" after you make sure.

## 6.4 How to use cut by code

Two ways of using the key code to make a key:

### Method 1:

Making a key without the original key:

Use some special tool to get the key code.

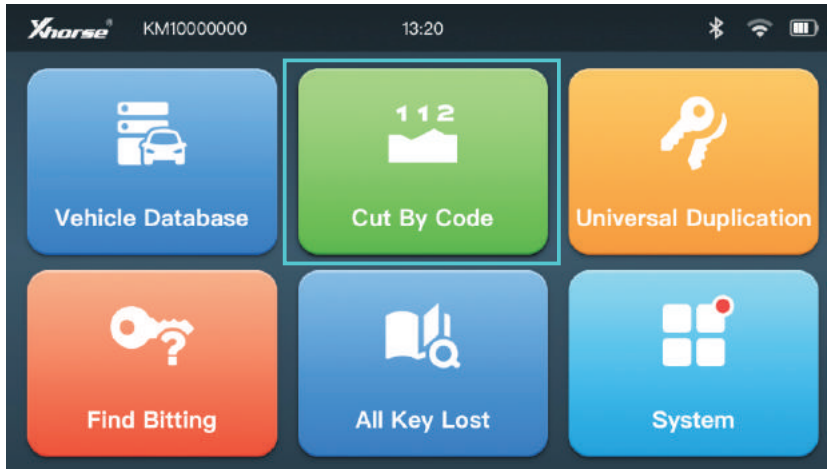

1) Click on "Cut By Code".

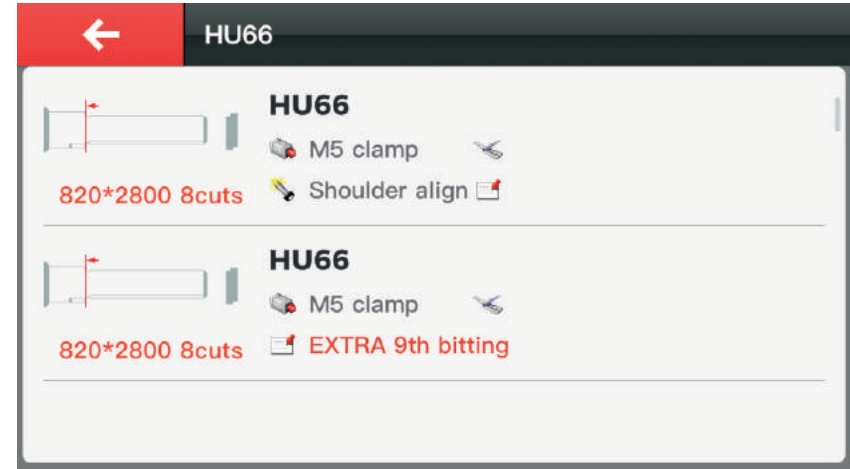

3) Select the key type.

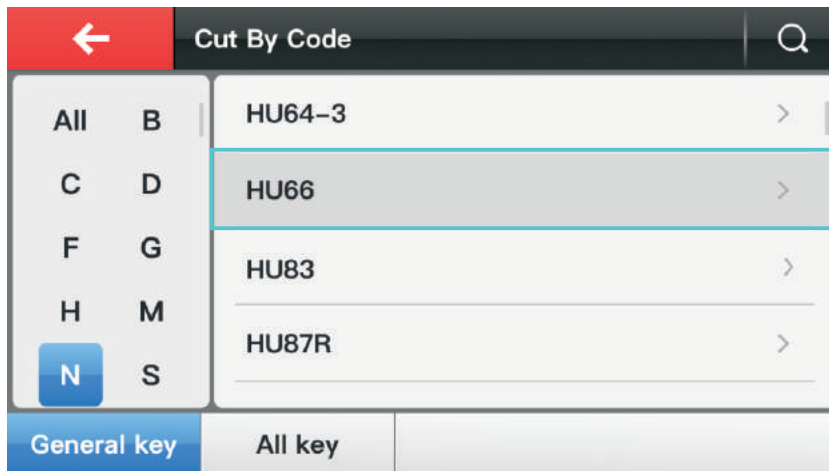

2) Select or input a key blank type.

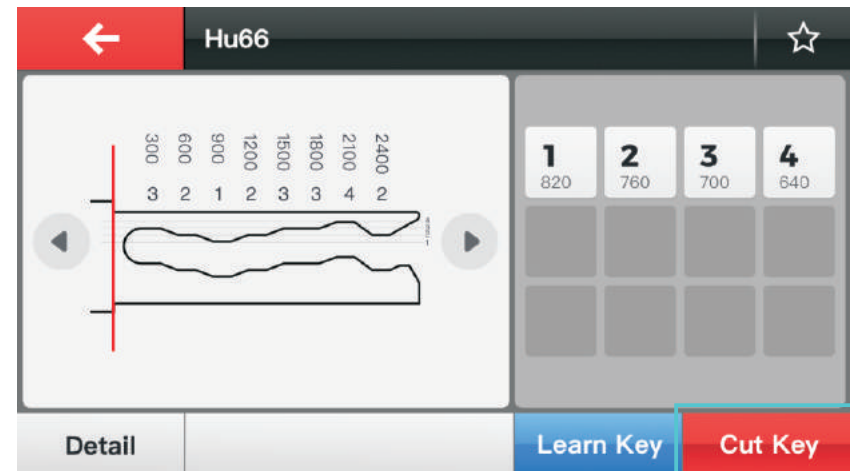

4) Fix the key according to the picture show, select proper side of clamp and fix the key in correct position. Put in the key bitting and check all the information before you click on "Cut Key" for make new key.

**Method 2:**

Making a key with the original key.

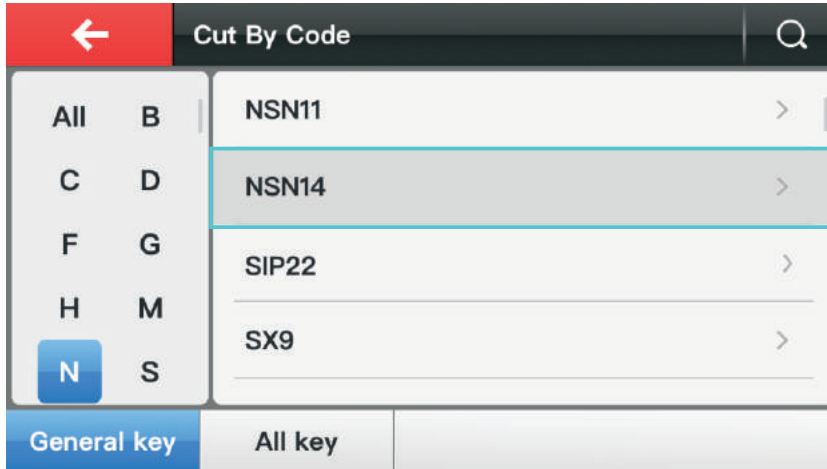

1) Click on "Cut By Code".

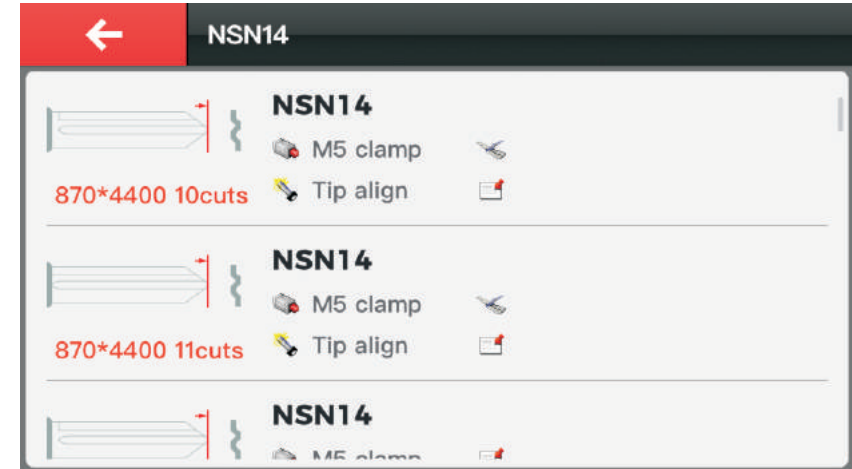

3) Select key type and click to enter the processing interface.

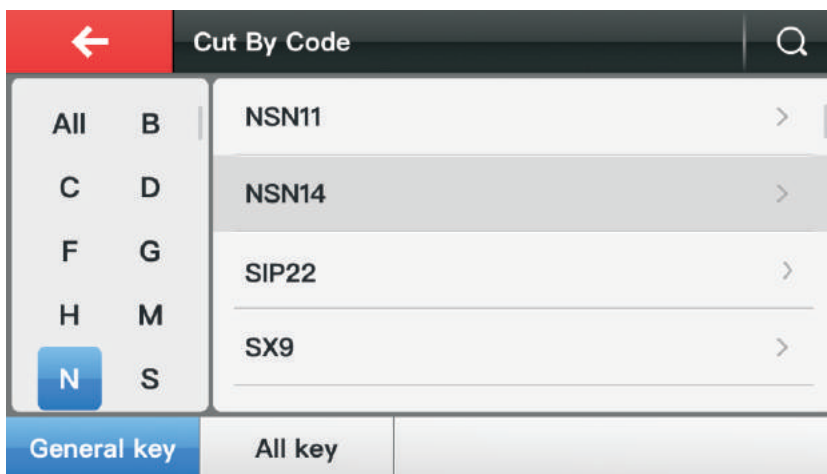

2) Select a key blank type.

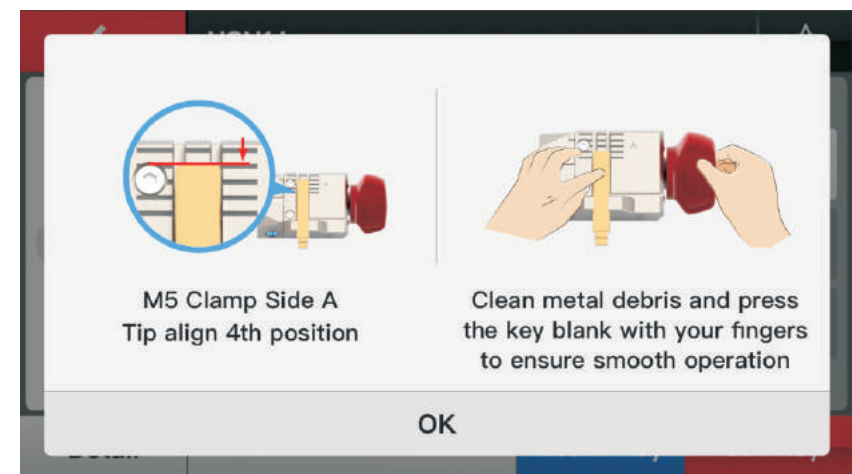

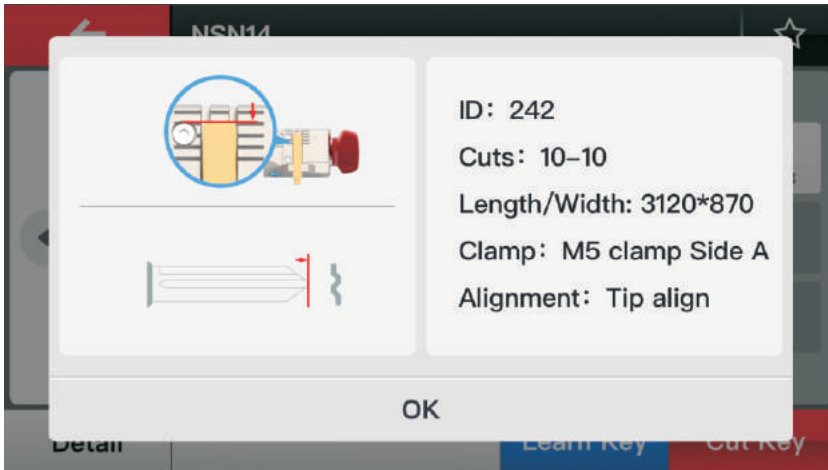

4) It will prompt the type of clamp for cutting and the key position after enter the processing interface, which can also be queried in "Detail".

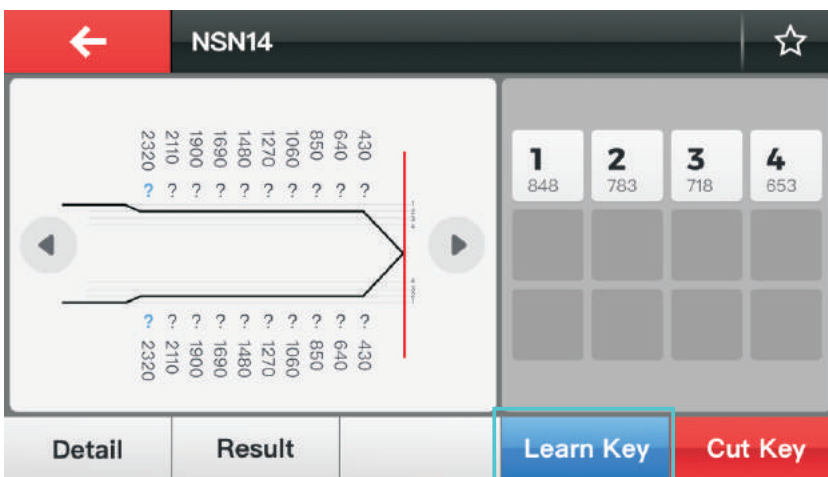
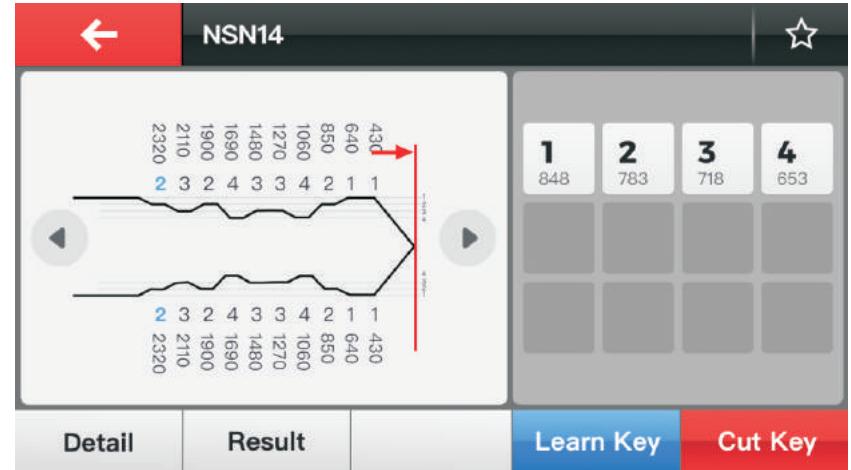

5) Click on "Learn Key".

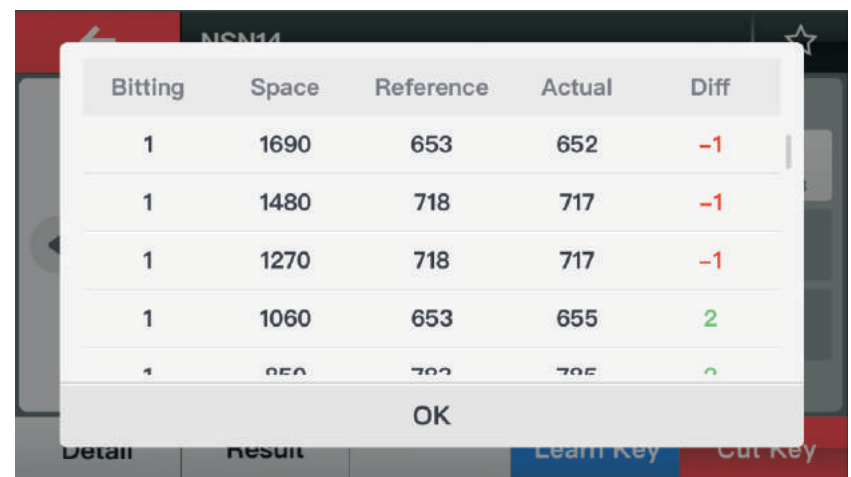

6) The original key code will be showed on screen after learn key. And you can view the Bitting, Space, Reference, Actual and Diff of each key code in the "Detail".

### 6.5 Universal Duplication

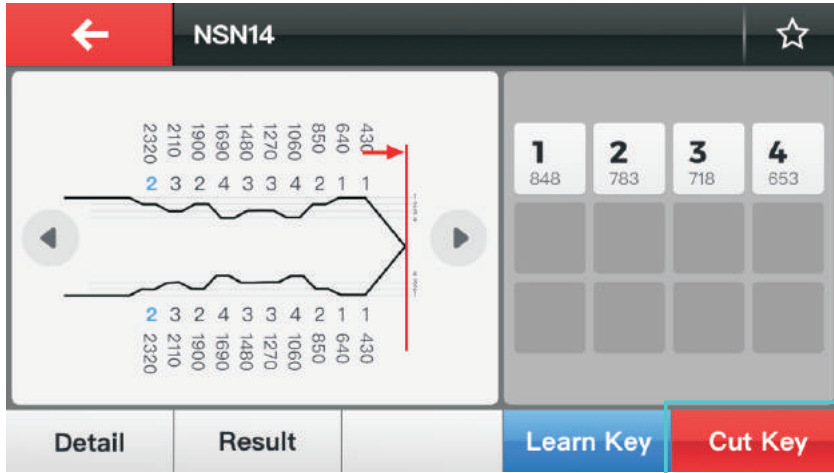

7) Click on "Cut Key" after you confirming that it is correct.

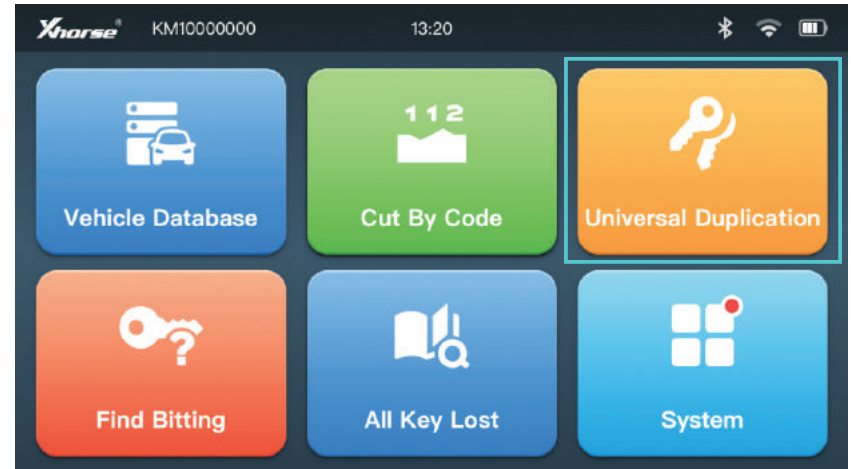

1) Click on "Universal Duplication".

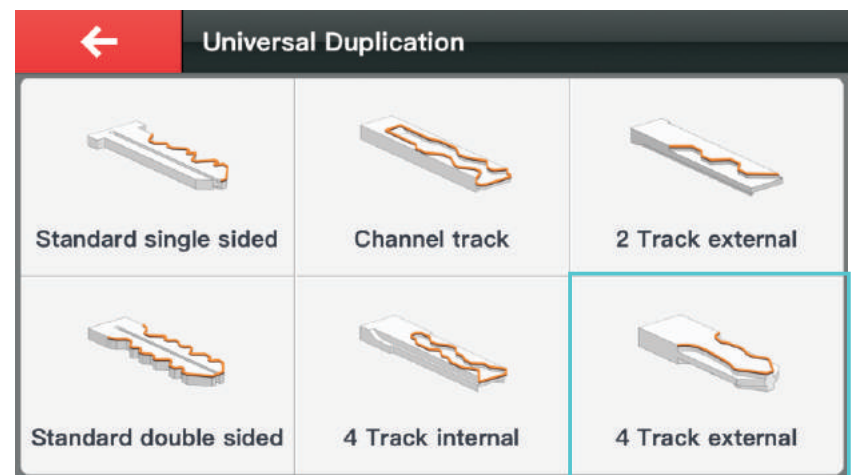

2) Take the track external key as an example, click on "4 Track external" to enter the corresponding interface.



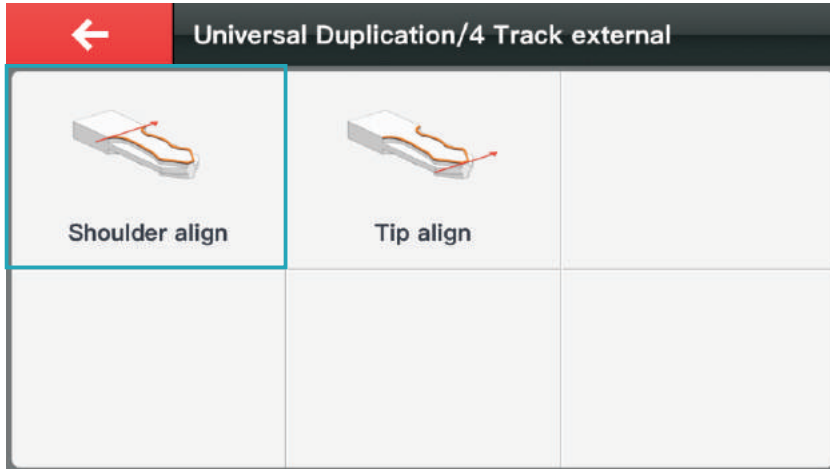

3) Choose the right alignment and clamp surface.

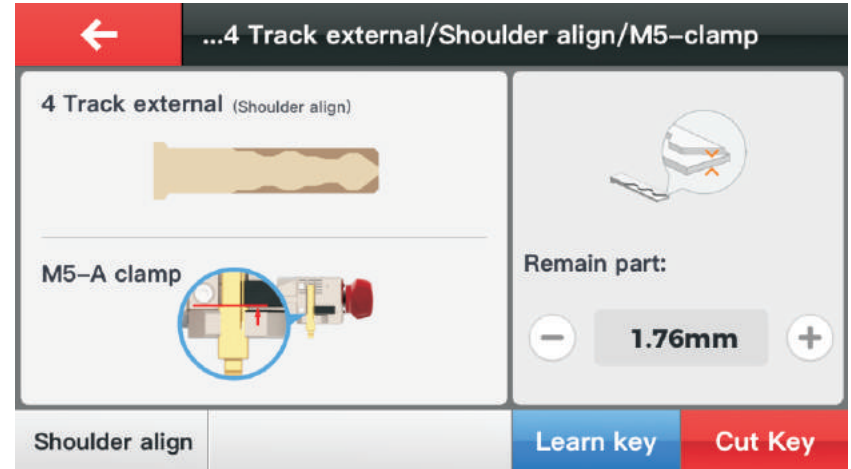

5) The "Cut Key" button will be change from gray to red after "Learn Key" completed, click on "Cut Key" to start and there will be a corresponding pop-up prompt after finish.

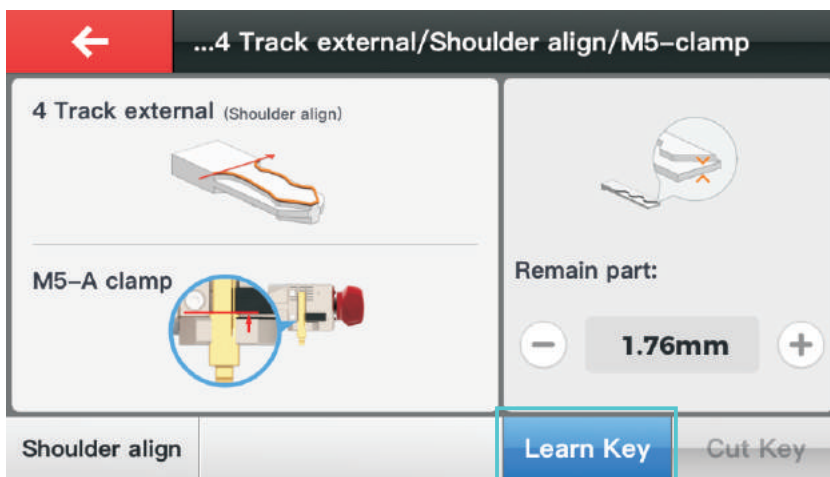

4) Click on "Learn Key" to start and there will be a corresponding pop-up prompt after finished.

## 6.6 How to use all key lost

\*The function requires search online, please keep the internet in good condition.

Three ways of using key database to make a key:

- 1.Key plate provided by the car factory.
- 2.The key bitting is printed on the lock of some models.
- 3.Obtain key bitting via other ways.



1) Click on "All Key Lost".

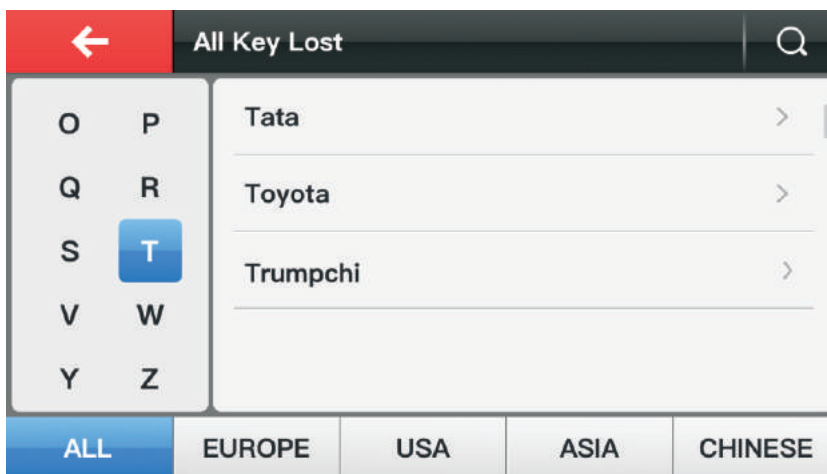

2) Select and click the car maker to enter next interface.

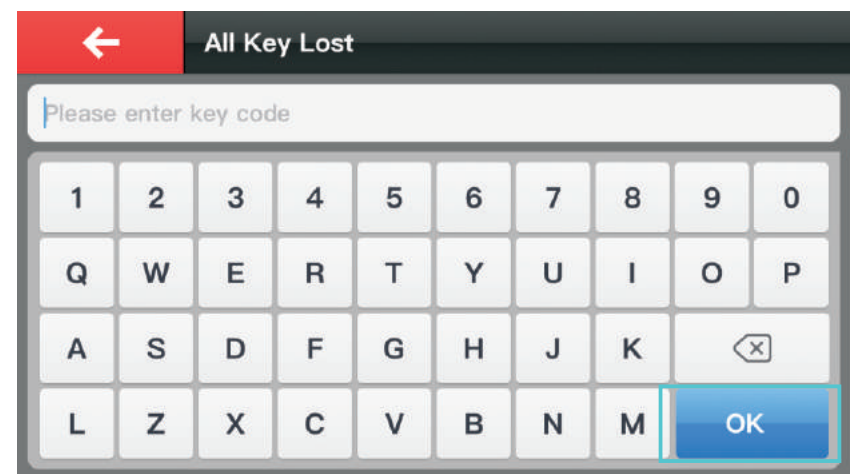
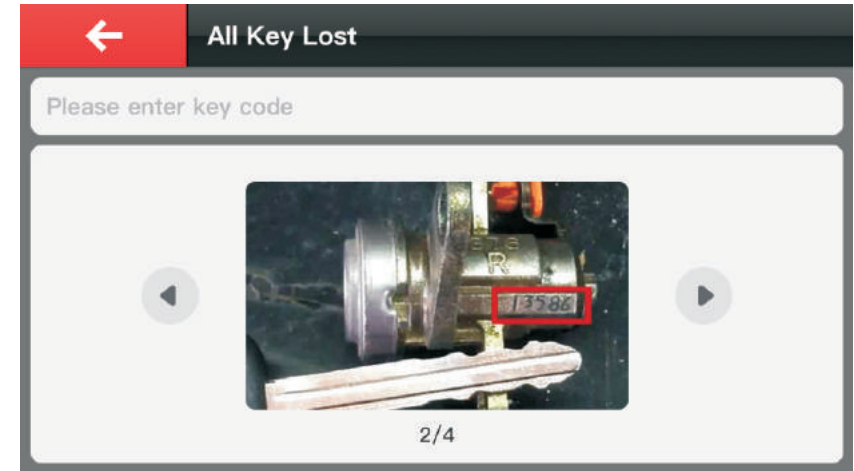

3) Enter key code and click on "OK".

### 6.7 How to use find biting

Parts of the cars are missing biting on door lock/trunk lock if compare with ignition lock. Users can find out the unknown biting and replace the unknown biting as "?". The system will display all possible results, you need to test and unlock after cutting to determine the final processed tooth profile.

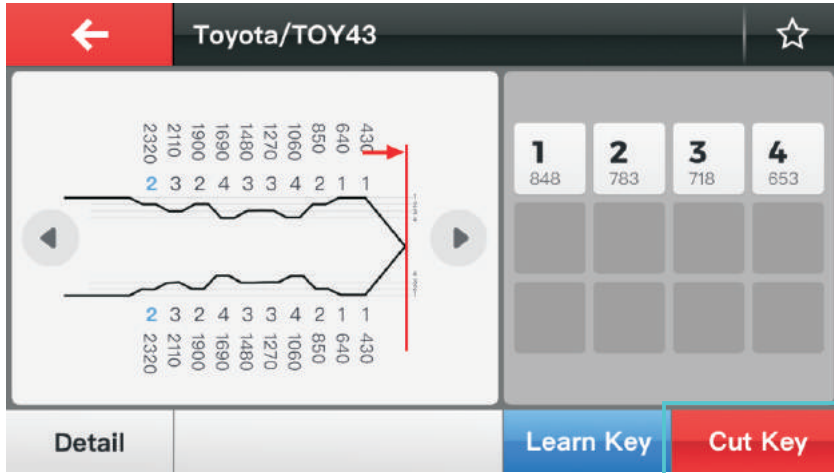

4) The key biting will generate automatically and click on "Cut Key" after you confirming it is correct.

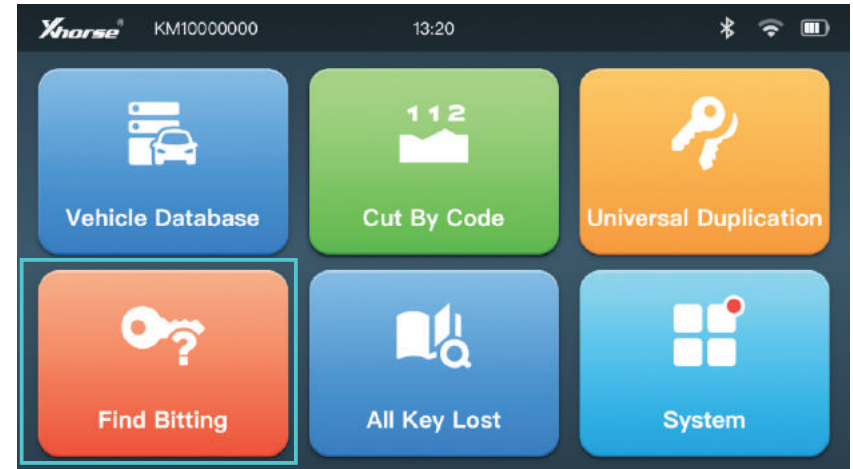

1) Click on "Find Bitting".

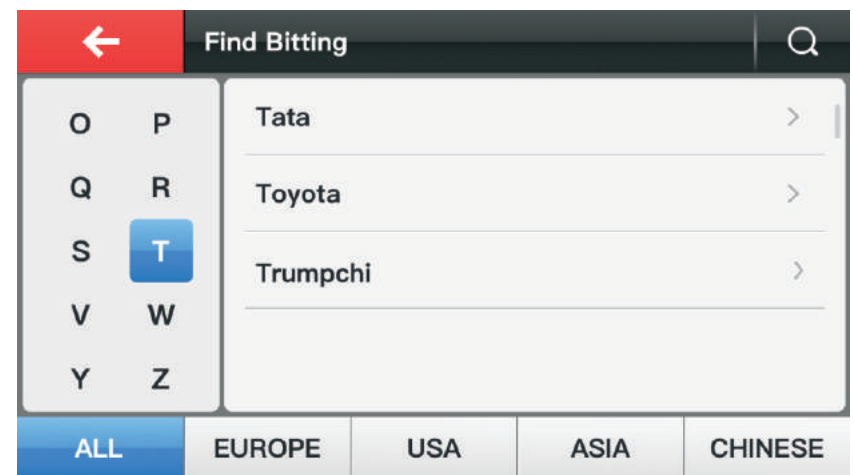

2) Select or input a car maker and click option to next interface.

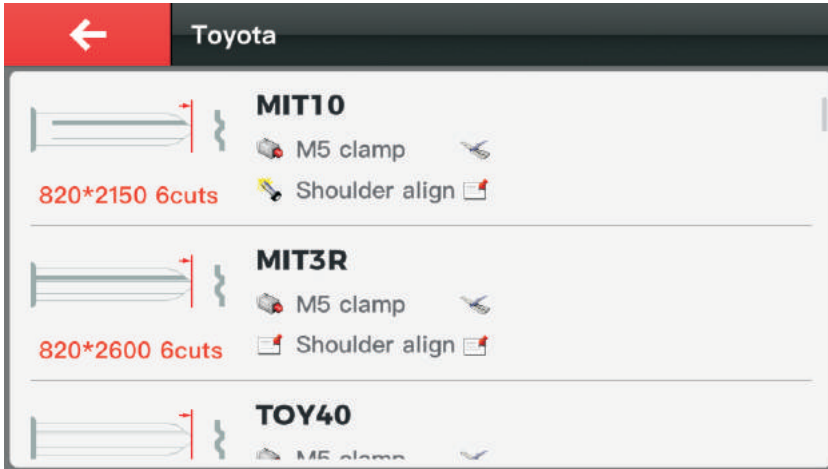

3) Select or input in the key blank type and click in.

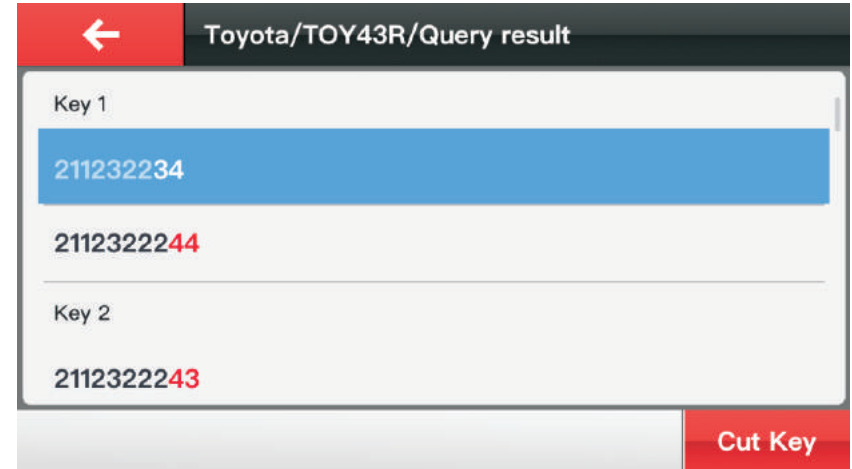

5) The system will display all possible results, you need to test and unlock after cutting to determine the final processed tooth profile.

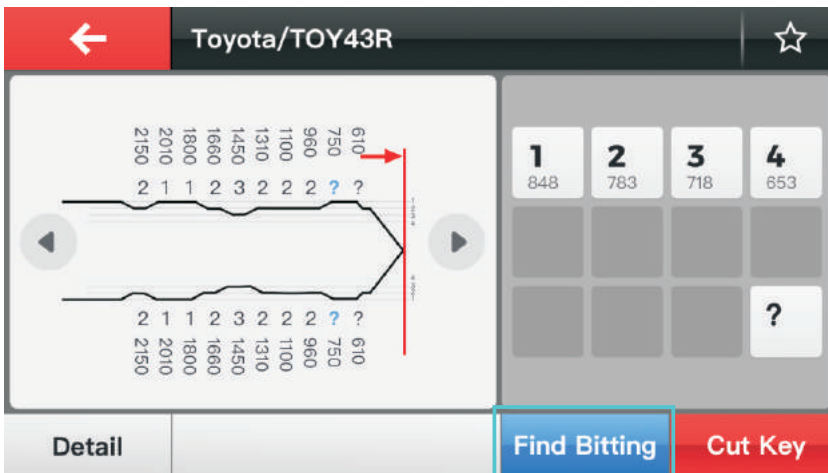

4) Put in the known bitting and replace unknown bitting as "?". Then click on "Find Bitting".

## 6.8 Special cutting option

It will show interface in the figure below when you cutting key by "Vehicle Database" or "Cut By Code".

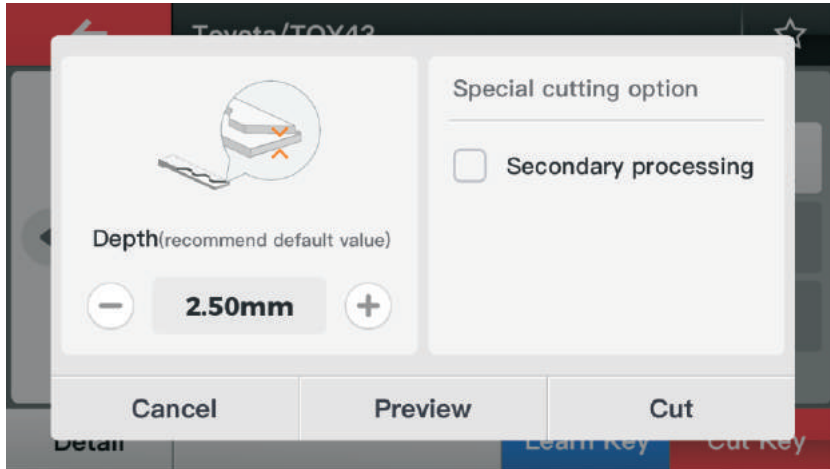

- 1) Secondary processing: The second cutting can be performed on the key blank that has been cut.
- 2) Cut according to the actual value of the bitting depth. When learn and cut key in the "VehicleDatabase" or "Cut By Code", the standard library bittings and parameters are used by default for cutting. If you need to cut according to the actual value, you need to select this item to cut after learning the original key.

## 7. System introduction

You will see "System" option at main interface. In this option, you can perform other operations besides cut key, such as machine calibration, cutting setting, language setting, query history, update version, WLAN connection, etc.

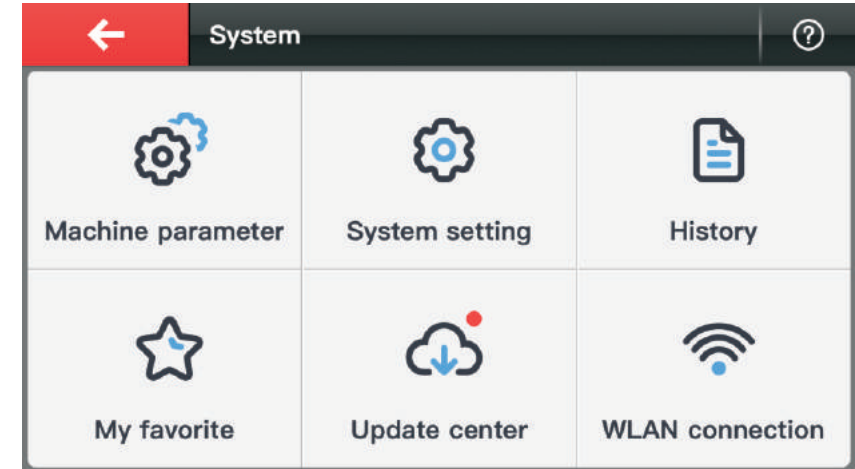

### 7.1 Machine Parameter

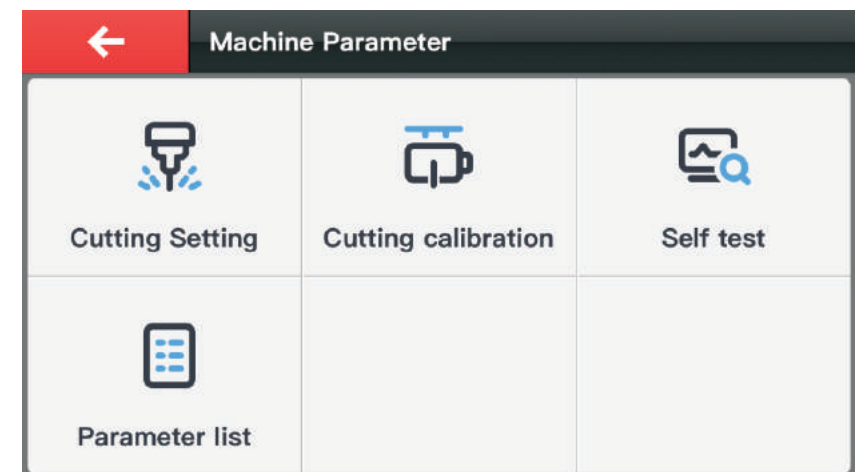

In the "Machine Parameter" interface, users can self test for machine, calibrate various parameters, and set the cutter diameter, cutter speed and move speed during cutting.

### 7.1.1 Cutting Setting

Users can set the spindle speed, move speed, cutter diameter and buzzer switch in the "Cutting Setting" interface.

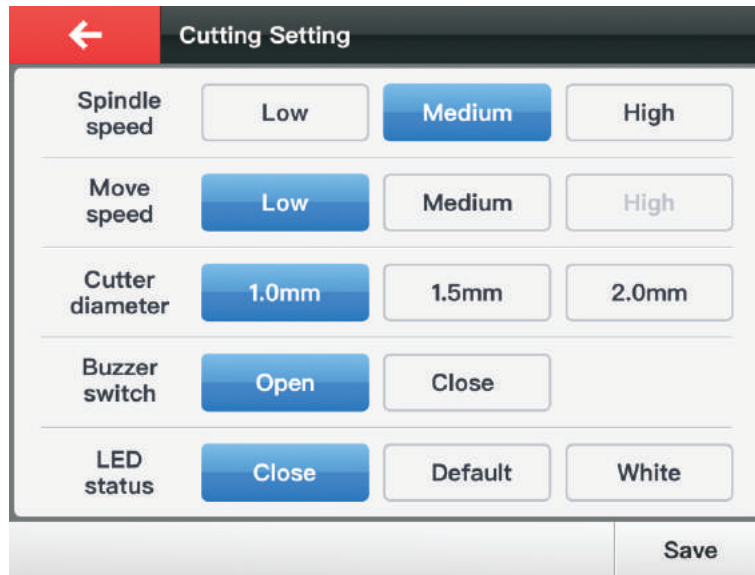

### 7.1.2 Machine Calibration

The following three items can calibrate the machine. (For the tutorial, please refer to Chapter 6.2)

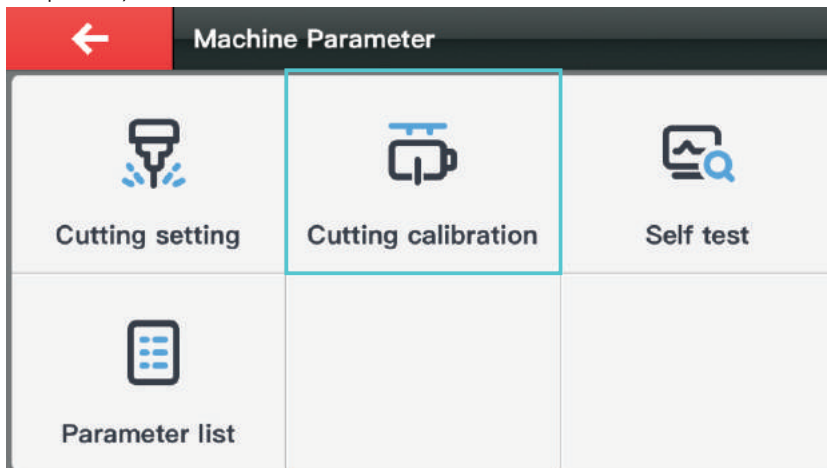

### 7.1.3 Self test

1. Deviation detection: Detect M5 clamp parameters.
2. Motor measurement: Check the status of X, Y, Z axis and spindle motor.
3. Electrical conductivity: Test the conductivity of probe and clamp, milling cutter and clamp.
4. Altitudes detection: Check whether the height of the probe and the milling cutter are on the same level.

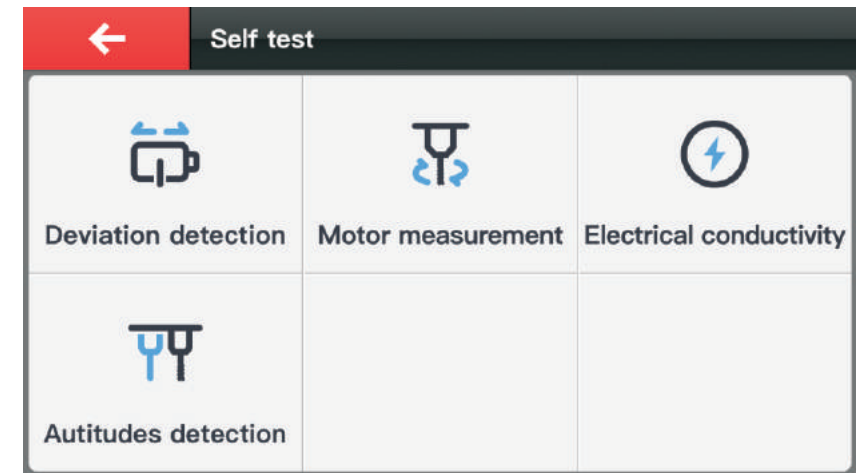

### 7.1.4 Parameter list

Display relative parameters between probe and milling cutter recorded by the machine.

PD	PDX	PDY	PDZ	DMoff
	24.00	0.00	0.00	0.00

## 7.2 System setting

In the "System setting" interface, Users can set the system language, startup password, quantity unit, etc.

1. Language setting: Change the Chinese and English display of the interface.
2. Set password: A startup password can be set to prevent children from touching the machine.
3. Unit setting: Set millimeters and inches freely as common units.
4. General setting: Switched on/off Bluetooth, adjust screen brightness, machine volume, time and date.

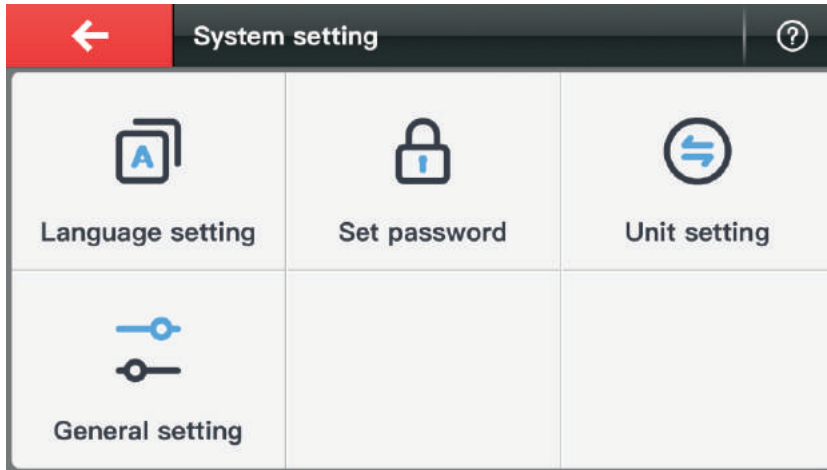

## 7.3 History

Users can query machine cutting records, make notes and cuts in the "History" interface. (This function requires networking)

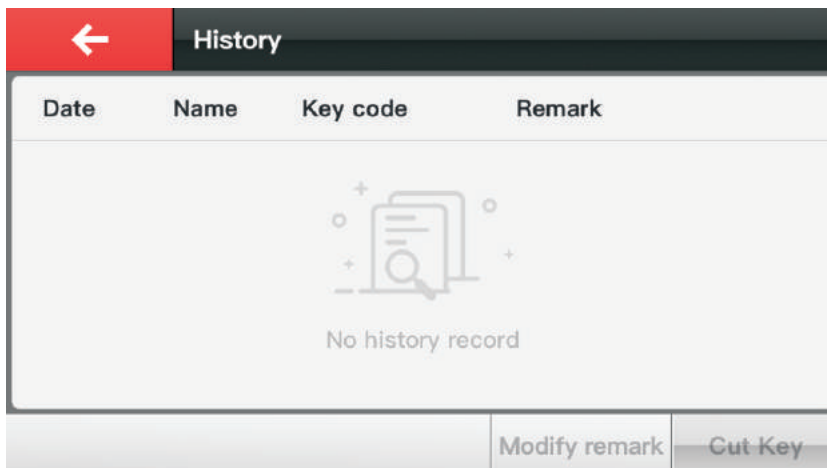

## 7.4 My favorite

In "Vehicle Database" or "Cut by Code", specific commonly used key blanks can be collected, and the collection button is located in the upper right corner of the interface. (As shown below)

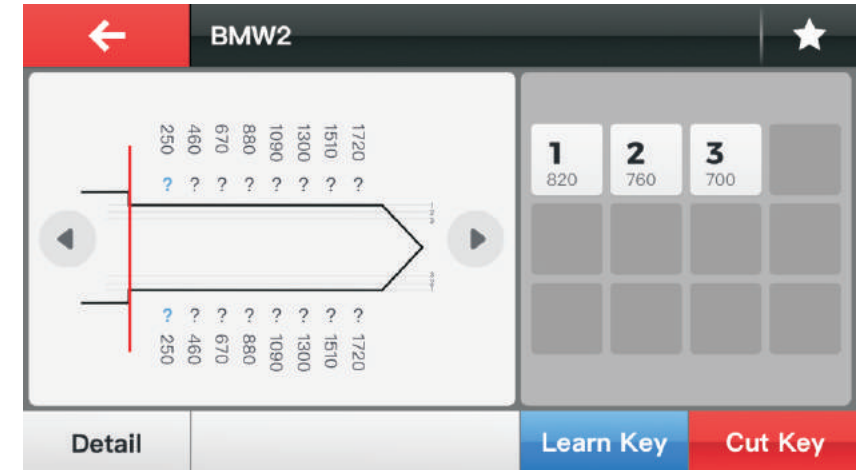

Users can find the option in "My Favorite" after collected, and open the processing interface for cutting operations quickly, (As shown below)

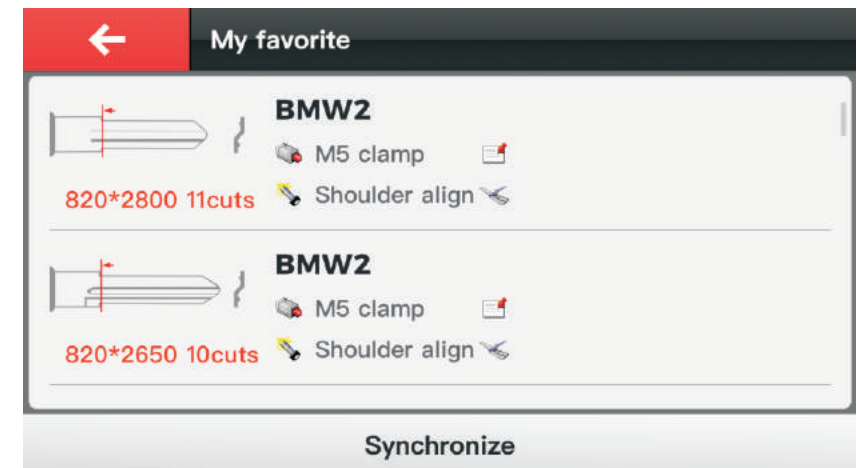

## 7.5 Update Center

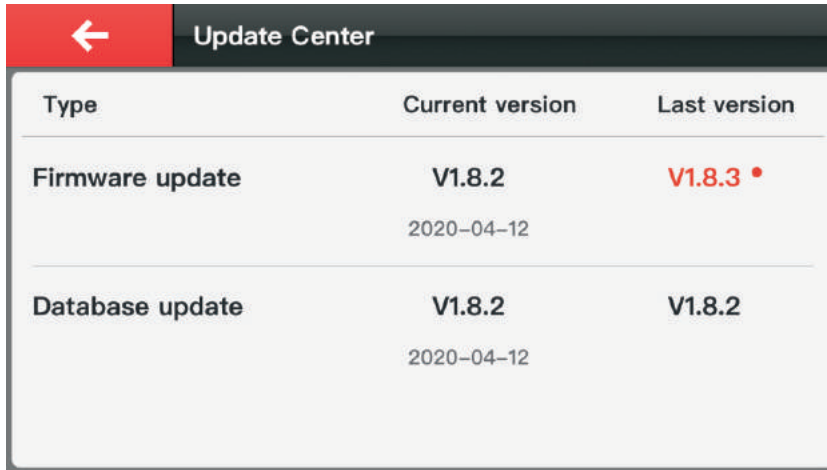

1) The “Update Center” interface will display the current system firmware and database version, and the updateable version will be marked with red to remind you to update.

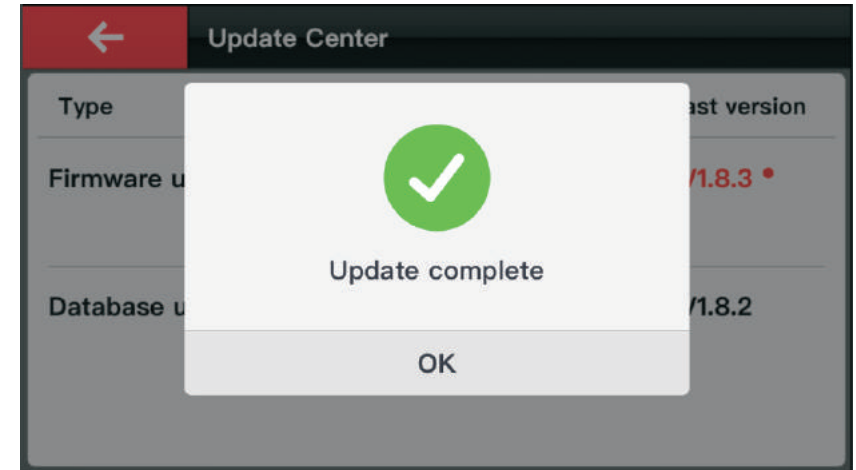

3) Click on “OK” to complete the update process after the update finished.

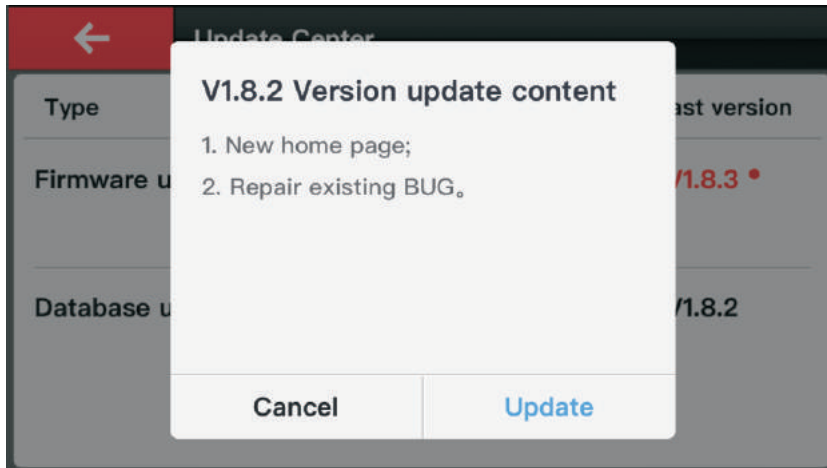

2) Click on the red label to see the version update content, and click “Update” to download the latest version.



## 7.6 WLAN Connection

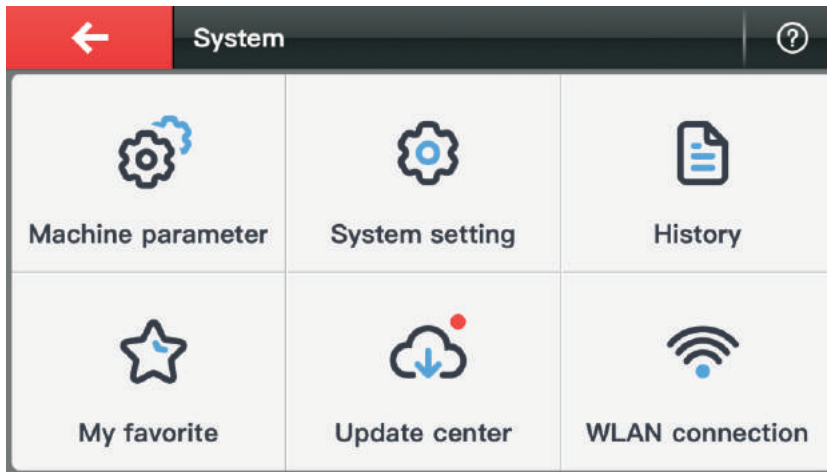

1) Entering "System" interface and click on "WLAN connection".

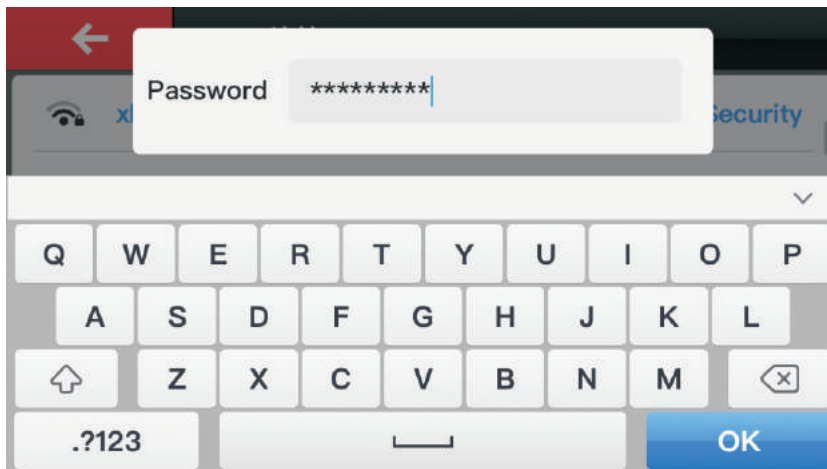

2) Select the available network and enter the network password, click on "OK" to complete the network connection.

## 8. Maintenance

- Please clean the area around clamps with a brush before the machine starts to work. This is to assure cutting precision and avoid components damage by metal particles.
- To avoid damage or corrosion to the machine, please do not use detergent or other cleaning products to clean the machine.
- Please do not flush or wet the machine with water, in case rust and electrical current leakage.
- Under any circumstance, please do not try to clean the working area with air guns and drying machines, in case any metal carvings getting inside the machine.

## 9. Warranty and after-sale description

DOLPHIN XP-005L has a warranty of 1 year for machine and six months for battery. The warranty starts from the date on invoice. If there is no invoice or the invoice is missing, purchase records from factory is used as reference.

Within Warranty, free maintenance and repairing is not provided if the machine becomes dysfunctional due to the following reasons:

- Operation without referring to or violating the user manual
- Modifications or repairs to the machine by individuals
- Falling, knocking or wrong voltage
- Force majeure
- Use of the machine in places such as ships that are bad for the machine for a long time
- Damaged or worn-out plastic case and protective shield due to frequent use

Regarding to customer service and technical support, please contact distributors or Xhorse online customer service team by scanning the QR code below and downloading Xhorse official App.



All the information and illustrations in this document are for guidance only. Xhorse reserves the right to alter products designs, dimensions or info to improve the products quality. The contents of this document are fully protected by Copyright and may not be copied or reproduced in any form (e.g. mechanical, electronic, printing or video recording), without permission from Xhorse.

### Federal Communication Commission (FCC) Radiation Exposure Statement

This device complies with part 15 of the FCC rules. Operation is subject to the following two conditions: (1) this device may not cause harmful interference, and (2) this device must accept any interference received, including interference that may cause undesired operation.

NOTE: The manufacturer is not responsible for any radio or TV interference caused by unauthorized modifications or changes to this equipment. Such modifications or changes could void the user's authority to operate the equipment.

NOTE: This equipment has been tested and found to comply with the limits for a Class B digital device, pursuant to part 15 of the FCC Rules. These limits are designed to provide reasonable protection against harmful interference in a residential installation. This equipment generates uses and can radiate radio frequency energy and, if not installed and used in accordance with the instructions, may cause harmful interference to radio communications. However, there is no guarantee that interference will not occur in a particular installation. If this equipment does cause harmful interference to radio or television reception, which can be determined by turning the equipment off and on, the user is encouraged to try to correct the interference by one or more of the following measures:

- -Reorient or relocate the receiving antenna.
- -Increase the separation between the equipment and receiver.
- -Connect the equipment into an outlet on a circuit different from that to which the receiver is connected.
- -Consult the dealer or an experienced radio/TV technician for help.

Any changes or modifications not expressly approved by the party responsible for compliance could void the user's authority to operate this equipment.

When using the product, maintain a distance of 20cm from the body to ensure compliance with RF exposure requirements.

### CE statement

This device is operated the frequency bands and the maximum output power (E.I.R.P) :

Bluetooth: 2402MHz – 2480MHz, 0.54 dBm;  
2.4GHz Wi-Fi: 2.412GHz - 2.472MHz, 17.56 dBm;  
5GHz Wi-Fi: 5180-5240MHz, 15.96 dBm;  
5745-5825MHz, 13.83dBm;

5150-5250MHz is for indoor use only.

CAUTION RISK OF EXPLOSION IF BATTERY IS REPLACED BY AN INCORRECT TYPE.  
DISPOSE OF USED BATTERIES ACCORDING TO THE INSTRUCTIONS.